

PU3 Underwater LED Light

PU3MLP, PU3MLP+B – Concrete Pools

PU3MLPW, PU3MLPW+B – Concrete Pools

PU3MLPL, PU3MLPL+B – Liner Pools

PU3MLPWL, PU3MLPWL+B – Liner Pools

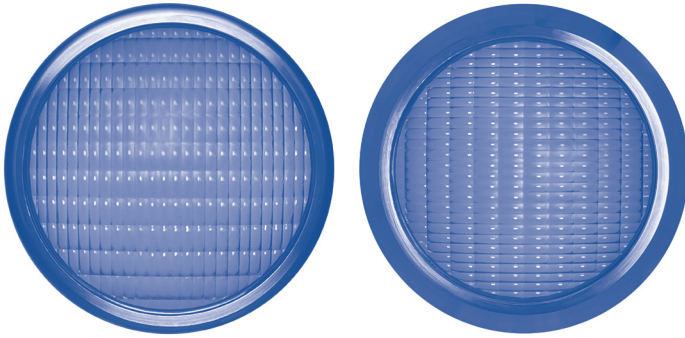

IMPORTANT:

READ CAREFULLY BEFORE USE. KEEP FOR FUTURE REFERENCE.

Notice to Installer:

The information within this document must be read before the installation and start-up of this product. Once the product has been installed this document must be given to the owner/operator of this equipment.

WARNING:

The RGBW Constant Current 350mA light will be damaged beyond repair if it is overpowered.

Please ensure that the Constant Current Driver (R4-CC) is set to 350mA before powering on.

Warranty is not applicable if used incorrectly.

 **WARNING** A qualified electrician must carry out all electrical wiring in accordance with local electrical regulations.



Product conformity information

This product complies with the following Statutory Instruments and Directives:

S.I. 2016:1091 ECR 2016 & 2014/30/EU EMC Directive:

- 22/30441335 DC
- BS EN IEC 61000-3-2:2019+A1:2021
- EN61000-3-3: 2013+A1: 2019

General Product Safety Regulations:

- EN60598-1: 2015+A1: 2018
- BS EN 60598-2-13:2006+A11:2021

S.I. 2012:3032 RoHS 2012 & 2011/65/EU RoHS Directive:

- BS EN IEC 62351-4:2018+A1:2020
- BS EN IEC 62351-5:2023
- IEC 62321-6: 2015
- IEC 62321-7-1: 2015
- BS EN 62321-7-2:2017
- IEC 62321-8: 2017

Safety Notices:

TO AVOID POSSIBLE HARM, READ AND FOLLOW THESE INSTRUCTIONS



DANGER

This notice signifies a hazard with a **HIGH** level of risk which, if not avoided, **WILL** result in death or serious injury.



WARNING

This notice signifies a hazard with a **MEDIUM** level of risk which, if not avoided, **COULD** result in death or serious injury.



DANGER

This notice signifies an **ELECTRICAL** hazard with a **HIGH** level of risk which, if not avoided, **WILL** result in death or serious injury.



WARNING

This notice signifies An **ELECTRICAL** hazard with a **MEDIUM** level of risk which, if not avoided, **COULD** result in death or serious injury.



CAUTION

This notice signifies a hazard with a **LOW** level of risk which, if not avoided, **COULD** result in minor or moderate injury.



NOTICE

This notice signifies a potential risk of damage to the product or property.

 **WARNING** This equipment must be installed by qualified persons only. Improper installation can create electrical hazards which could result in property damage, serious injury or death. Improper installation and servicing will void the warranty.

 **WARNING** A qualified electrician must carry out all electrical wiring in accordance with local electrical regulations.

 **NOTICE** Do not operate the light in a 'non-wet' environment for long periods.

About the product

The PU3 LED Light is a full colour changing or mono-colour (RGBW), or single white (W) light. The RGBW unit offers the flexibility to allow a choice of colours and shades, create programmable lighting sequences and to be dimmable. The W unit is a simple on/off white light

It can be used as a stand alone light, or in multiples.

This product is specifically designed for use as an underwater swimming pool light. The light is IP68 rated making it suitable for permanent immersion in water.

This product is a Class III electric apparatus – it is designed to be powered by a SELV (Safety Extra Low Voltage) power source.

⚠ WARNING A qualified electrician must carry out all electrical wiring in accordance with local electrical regulations.

Model No:	Description
PU3MLP, PU3MLP+B	Large LED Light (RGBW) - for Concrete Pools
PU3MLPW, PU3MLPW+B	Large LED Light (WHITE) – for Concrete Pools
PU3MLPL, PU3MLPL+B	Large LED Light (RGBW) - for Liner Pools
PU3MLPWL, PU3MLPWL+B	Large LED Light (WHITE) – for Liner Pools

The design of the PU3MLP, PU3MLP+B PU3MLPW, PU3MLPW+B lights makes them suitable for a push fit application into open ended 1 1/2” Class C piping, leaving just the fascia of the light visible on the swimming pool wall. These lights also come with an alternative sized o-ring making them suitable for installation into 50mm Class C piping.

The design of the PU3MLPL, PU3MLPL+B PU3MLPWL, PU3MLPWL+B light makes them suitable for use in vinyl liner pools by means of a threaded attachment into a new or existing Certikin liner inlet fitting.

RGBW units are designed to be operated and controlled by a separate Wi-Fi controller, driver unit and power supply. W units are designed to be operated as an on/off light from a separate power supply.

Technical Specification (Concrete Pool Lights)		
Model	PU3MLP, PU3MLP+B	PU3MLPW, PU3MLPW+B
Rated Power	20W	
Input	24VDC	12VDC
Drive Mode	External Constant Current Driver (Model: R4-CC)	N/A
Drive Current	RGBW: 350mA	N/A
Control	WIFI 104	Switch power on/off
Product Dimension (We reserve the right to change product dimensions without notice if this does not compromise the critical performance criteria of the product).	<p style="text-align: center;">PU3 Concrete V3.2</p>	
Lens Angle	120°	
Weight	3kg	
Light Source	White/RGB/RGBW	White (5000-5200k)
Lumen	White: 2000-2300, RGBW: 520-570	2000-2300lm
CRI	Ra>85	
Max. Life Time	50,000H	
Housing Material	316 Stainless Steel	
Cover Material	PC	
Working Temperature	-20°C ~ 50°C	
IP Grade	IP68	
Mounting Type	Push fit into Class C 1.5" pipe (alternative o-rings included for fit into Class C 50mm pipe)	
Cable Length	20m	
Coverage	20m ²	

Technical Specification (Liner Pool Lights)		
Model	PU3MLPL, PU3MLPL+B	PU3MLPWL, PU3MLPWL+B
Rated Power	20W	
Input	24VDC	12VDC
Drive Mode	External Constant Current Driver (Model: R4-CC)	N/A
Drive Current	RGBW: 350mA	N/A
Control	WIFI 104	Switch power on/off
Product Dimension (We reserve the right to change product dimensions without notice if this does not compromise the critical performance criteria of the product).		
Lens Angle	120°	
Weight	3.5kg	
Light Source	White/RGB/RGBW	White (5000-5200k)
Lumen	White: 2000-2300, RGBW: 520-570	2000-2300lm
CRI	Ra>85	
Max. Life Time	50,000H	
Housing Material	316 Stainless Steel	
Cover Material	PC	
Working Temperature	-20°C ~ 50°C	
IP Grade	IP68	
Mounting Type	Screw fit into new or existing Certikin liner inlet (with or without socket nipple connection)	
Cable Length	20m	
Coverage	20m ²	

⚠ NOTICE This product contains no serviceable or changeable parts. Do not attempt to open the light housing. Opening the light housing will void all warranty.



Once expired, this product should not be disposed of via general waste, but through a regulated waste disposal and recycling centre – please consult your local authority for full advice.

Installation

⚠ WARNING This equipment must be installed by qualified persons only. Improper installation can create electrical hazards which could result in property damage, serious injury or death. Improper installation and servicing will void the warranty.

⚠ WARNING A qualified electrician must carry out all electrical wiring in accordance with local electrical regulations.

For concrete pools – PU3MLP, PU3MLPW, PU3MLP+B, PU3MLPW+B

List of supplied components

- PU3 LED Light incl 20m cable pre-wired
- 2 x o-rings (fitted) for Class C 1 1/2" pipe fitting (PU3MLP & PU3MLPW only)
- 2 x o-rings (bagged) for Class C 50mm pipe fitting (PU3MLP & PU3MLPW only)
- Information for use document

This light is designed to be inserted into 1 1/2" pipe which has been cut flush and sealed at the pool wall face. It is recommended that the receiving pipe/s be situated between 400-700mm below water level.

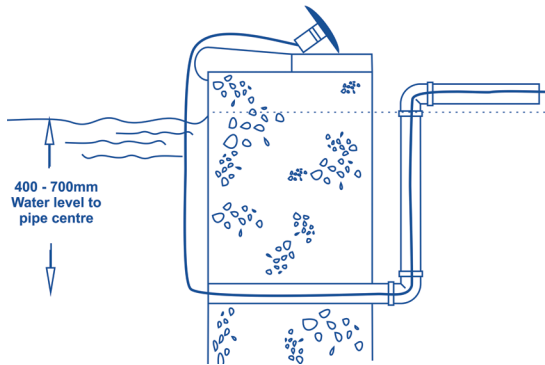

The receiving pipe should be extended/converted to conduit which then runs **above** the water level to create a run for the cable to the central control/power point.

When the light cable is fed through the receiving pipe/conduit, sufficient cable should remain free within the pipe in order to be able to remove the light unit to the pool surround.

Run the cable through the pipe/conduit back to the desired control/power point.

Coil the free cable into the pipe and insert the light body – the o-rings around the light will create a friction fit. The o-rings do not act as a watertight seal. **The use of a suitable lubricant on the o-rings will make the insertion of the light into the pipe easier.**

Multiple lights can be installed within a single pool.

For vinyl liner pools – PU3MLPL, PU3MLPWL, PU3MLPL+B, PU3MLPWL+B

List of supplied components

- PU3 LED Light incl 20m cable pre-wired
- Information for use document

This light is designed to be installed into a Certikin liner inlet fitting connected to either 1½” or 2” pipe. It is recommended that the receiving fitting/s be situated between 400-700mm below water level.

⚠ NOTICE The inlet fitting should be for use by the light only – it should not be connected to the pool circulation system.

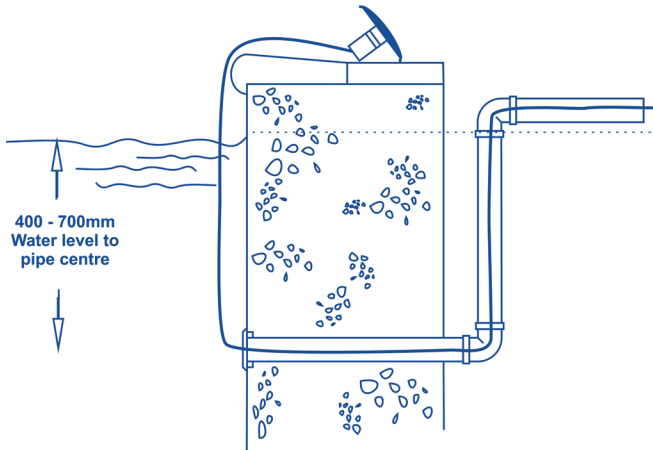

The liner fitting and the liner should be installed as normal. The light body is threaded and shaped in order to be a perfect fit into and over the liner inlet clamp plate.

The pipework connected to the inlet fitting/s should be extended/converted to conduit which then runs **above** the water level to create a run for the cable to the central control/power point.

When the light cable is fed through the receiving pipe/conduit, sufficient cable should remain free within the pipe in order to be able to remove the light unit to the pool surround.

Run the cable through the pipe/conduit back to the desired control/power point.

Coil the free cable into the pipe and insert the light body – position the light body within the inlet fitting and screw the light into place. When fully installed the light body will cover the inlet clamp plate exactly.

Multiple lights can be installed within a single pool.

RGBW lights

Each RGBW light requires its own R4-CC driver unit (supplied separately) but multiples can be powered and controlled by a single power supply and Wi-Fi 104 receiver/transmitter (supplied separately).

The following control items are recommended and available from Certikin, for powering of up to 26 lights:

PU2MLPS	Power Supply 24v 320w
PU2MLWC	Wi-Fi 104 Controller
PU2MLRC	R4-CC Driver Receiving Controller
PU2MLE	Wall Mounted ABS Enclosure For Power Supply

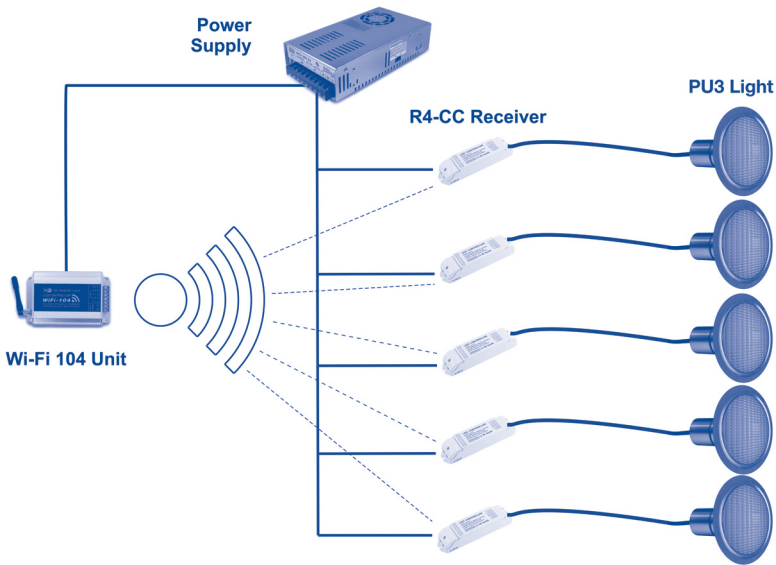

⚠ WARNING Refer to and follow in the installation and operation instructions of each individual component.

⚠ WARNING The Constant Current Driver must have the dip switches set to 350mA (both switches in the OFF position)

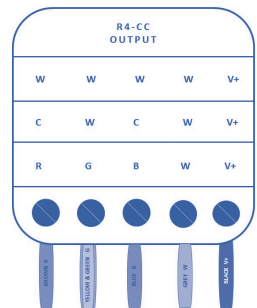

White (W) lights:

White lights operate as a simple switch power on/off only, however multiple lights can be powered by a single power supply.

The following power supply is available from Certikin, for powering of up to 16 lights:

PU2MLPS12V	Power Supply 12v 320W (White light only)
------------	--

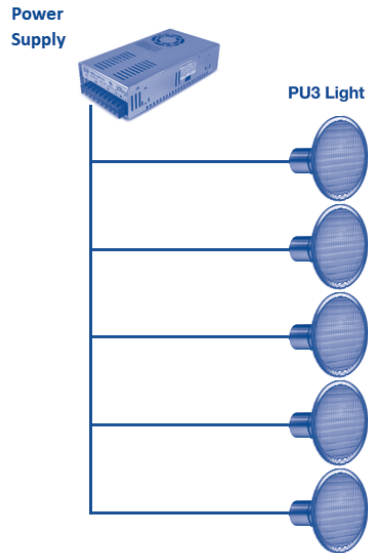

⚠ WARNING Refer to and follow in the installation and operation instructions of each individual component.

Operation:

RGBW lights are operated via the control unit and/or App provided with the Wi-Fi 104 unit. Please refer to these instructions for operational procedures relating to the light.

White lights are controlled by an in-line switch (not supplied) – this switch can be manual or automatic/timed.

⚠ WARNING A qualified electrician must carry out all electrical wiring in accordance with local electrical regulations.

Maintenance:

⚠ NOTICE This product contains no serviceable or changeable parts. Do not attempt to open the light housing. Opening the light housing will void all warranty.

Troubleshooting:

SYMPTOM	POSSIBLE CAUSE	POSSIBLE SOLUTION
Light does not operate	No power to the light	Refer to qualified electrician to check wiring and power supply
	Lack of control signal	Refer to Wi-Fi 104 instructions
Failure of single light within bank of lights	Failure of single R4-CC driver	Refer back to installer/qualified electrician – interchange alternative light and test if working/test non-illuminating light with alternative driver to test if working. Replace driver if appropriate.
	Failure of single light	Refer back to installer/qualified electrician – interchange alternative light and test if working/test non-illuminating light with alternative driver to test if working. Replace light if appropriate.

Manufactured By:
Maysee Technology Ltd, China

Imported By:
Certikin International Ltd
Unit 4, Tungsten Park
Colletts Way
Witney
Oxfordshire
OX29 0AX

✉ info@certikin.co.uk

www.certikin.co.uk

JANUARY 2024

Certikin
FLUIDRA